

# @lgood



Locks and latches

The 71 Series modular lock system is a full suite of heavy duty mortice locks for unsprung door furniture with many benefits.

- Modular case sizes for easier door preparation.
- 80mm and 100mm backset options also available. Contact Allgood for details.
- Low friction latchbolts gives a smoother and quieter locking action and reduces damage to the door.
- Reversible strike plates.
- Unique 'griptight' followers which prevent movement of the spindle within the follower, thus eliminating looseness of lever handles
- Solid stainless steel latchbolts, deadbolts and followers provide enhanced durability and security.
- High quality springs in locks and latches for lever handles provide enhanced durability and prevent lever handles from sagging.
- Radiused faceplates and strikeplates are available to allow router preparation of doors and frames in the factory.



## 7104F60

Vertical mortice latch.

- Heavily sprung for lever handles
- Reversible latchbolt without opening lockcase
- Bolt through fixing holes for furniture
- Complete with strike plate. Specify **7104FS60** for lock with radius strike plate.
- Independently tested to BS EN 12209 **3X10GB020**
- CE Marked 1121-CPD-AG0062
- Certifire approved CF 537
- Incorporated in successful fire test and assessed to BS EN 1634-1 and BS 476 Pt 22 up to 90 minutes on timber doors and 120 minutes on metal doors
- 10 year guarantee

**Finishes:** SS • PS

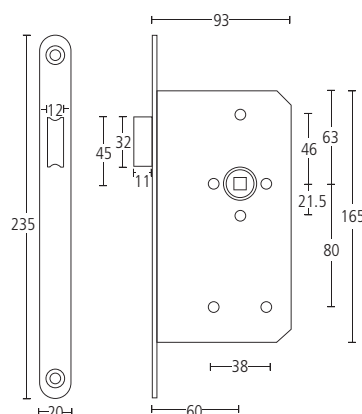

## 7108F60

Vertical mortice bathroom lock.

- Heavily sprung for lever handles
- Reversible latchbolt without opening lockcase
- Bolt through fixing holes for furniture
- Complete with strike plate. Specify **7108FS60** for lock with radius strike plate.
- Independently tested to BS EN 12209 **3X10G-B020**
- CE Marked 1121-CPD-AG0061
- Certifire approved CF 537
- Incorporated in successful fire test and assessed to BS EN 1634-1 and BS 476 Pt 22 up to 90 minutes on timber doors and 120 minutes on metal doors
- 10 year guarantee

**Finishes:** SS • PS

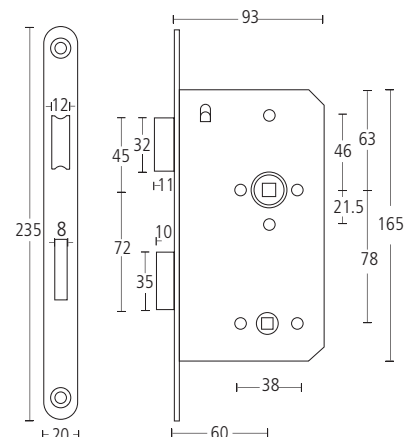



### 7125F60

Vertical lift to lock (L2L) mortice lock.

- The internal lever has a dual function. When lifted up, the lever simultaneously throws the deadbolt and actuates the external indicator. Depressing the inside lever withdraws the deadbolt, the latchbolt and resets the indicator. The external lever only operates latchbolt.
- Heavily sprung for lever handles
- Reversible latchbolt without opening lockcase
- Bolt through fixing holes for furniture
- Complete with strike plate. Specify **7125FS60** for lock with radius strike plate.
- Independently tested to BS EN 12209 **3X|8|1|0|G|-B|0|3|0**
- CE Marked 1121-CPD-AG0104
- Certifire approved CF 347
- Incorporated in successful fire test and assessed to BS EN 1634-1 and BS 476 Pt 22 up to 90 minutes on timber doors and 120 minutes on metal doors
- 10 year guarantee

**Finishes:** SS • PS

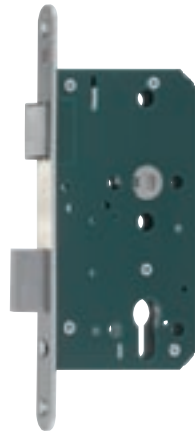
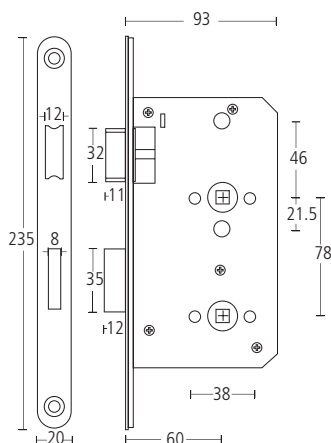

### 7178F60

Vertical euro profile cylinder mortice emergency lock.

- Inside lever handle withdraws both latch and deadbolt in one action, allowing escape for fire and safety reasons, without compromising security as per 'Secured by Design'.
- Heavily sprung for lever handles
- Internal lever handle requires a XX9052NT half spindle
- Reversible latchbolt without opening lockcase
- Bolt through fixing holes for furniture
- Complete with strike plate. Specify **7178FS60** for lock with radius strike plate.
- Independently tested to BS EN 179 **3|7|6|B|1|3|4|2|A|B** and **3|7|6|B|1|3|4|2|A|D**
- CE Marked 1121-CPD-ABB035
- Certifire approved CF 347
- Incorporated in successful fire test and assessed to BS EN 1634-1 and BS 476 Pt 22 up to 90 minutes on timber doors and 120 minutes on metal doors
- 10 year guarantee

**Finishes:** SS • PS

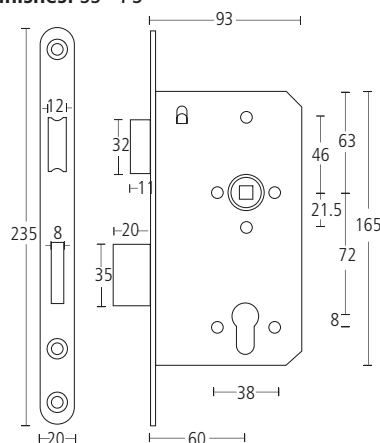

The 71 Series modular lock system is a full suite of heavy duty mortice locks for unsprung door furniture with many benefits.

- Modular case sizes for easier door preparation.
- 80mm and 100mm backset options are available. Contact Allgood for details.
- Low friction latchbolts gives a smoother and quieter locking action and reduces damage to the door.
- Reversible strike plates.
- Unique 'griptight' followers which prevent movement of the spindle within the follower, thus eliminating looseness of lever handles
- Solid stainless steel latchbolts, deadbolts and followers provide enhanced durability and security.
- High quality springs in locks and latches for lever handles provide enhanced durability and prevent lever handles from sagging.
- Radiused faceplates and strikeplates are available to allow router preparation of doors and frames in the factory.



## 7179F60

Vertical euro profile cylinder mortice lock.

- Heavily sprung for lever handles
- Reversible latchbolt without opening lockcase
- Bolt through fixing holes for furniture
- Complete with strike plate. Specify **7179FS60** for lock with radius strike plate.
- Independently tested to BS EN 12209 **3X810G4BA20**
- CE Marked 1121-CPD-AG0060
- Certifire approved CF 537
- Incorporated in successful fire test and assessed to BS EN 1634-1 and BS 476 Pt 22 up to 90 minutes on timber doors and 120 minutes on metal doors
- 10 year guarantee

**Finishes:** SS • PS

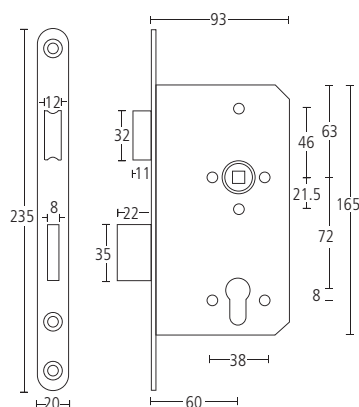

## 7181F60

Vertical euro profile cylinder mortice nightlatch.

- Anti thrust bolt inhibits the latch from being forced back when in the locked position
- Heavily sprung for lever handles
- Reversible latchbolt without opening lockcase
- Bolt through fixing holes for furniture
- Complete with strike plate. Specify **7181FS60** for lock with radius strike plate.
- Independently tested to BS EN 179 **376B1342AB** and **376B1342AD**
- CE Marked 1121-CPD-ABB035
- Certifire approved CF 347
- Incorporated in successful fire test and assessed to BS EN 1634-1 and BS 476 Pt 22 up to 90 minutes on timber doors and 120 minutes on metal doors
- 10 year guarantee

**Finishes:** SS • PS

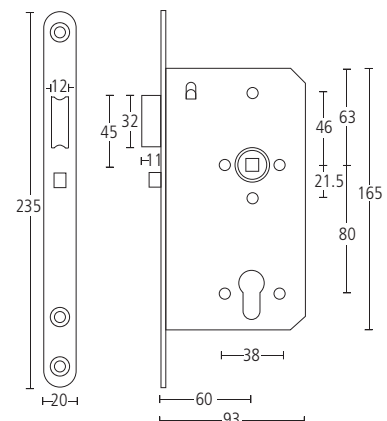



### 7182F60

Vertical euro profile cylinder mortice lock.

- Lever handles on both sides will withdraw latch bolt. If deadbolt is projected, the inside handle only will withdraw both bolts. Door then remains unlocked until manually re-locked by key from outside or turn from inside.
- Supplied with split spindle
- Heavily sprung for lever handles
- Reversible latchbolt without opening lockcase
- Bolt through fixing holes for furniture
- Complete with strike plate. Specify **7182F560** for lock with radius strike plate.
- Independently tested to BS EN 179 

3	7	6	B	1	3	4	2	A	B
---	---	---	---	---	---	---	---	---	---

 and 

3	7	6	B	1	3	4	2	A	D
---	---	---	---	---	---	---	---	---	---
- CE Marked 1121-CPD-ABB035
- Certifire approved CF 347
- Incorporated in successful fire test and assessed to BS EN 1634-1 and BS 476 Pt 22 up to 90 minutes on timber doors and 120 minutes on metal doors
- 10 year guarantee

Finishes: SS • PS

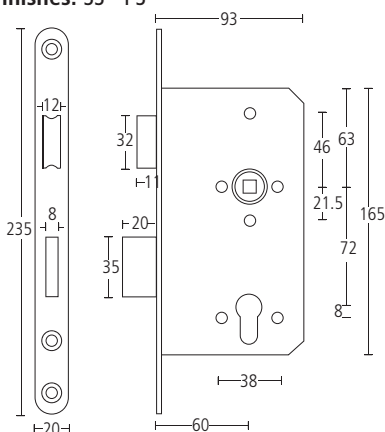

### 7186F60

Vertical euro profile cylinder mortice deadlock.

- Bolt through fixing holes for furniture
- Complete with strike plate. Specify **7186F560** for lock with radius strike plate.
- Independently tested to BS EN 12209 

3	X	8	1	0	G	4	B	A	0	0
---	---	---	---	---	---	---	---	---	---	---
- CE Marked 1121-CPD-AG0059
- Certifire approved CF 537
- Incorporated in successful fire test and assessed to BS EN 1634-1 and BS 476 Pt 22 up to 90 minutes on timber doors and 120 minutes on metal doors
- 10 year guarantee

Finishes: SS • PS

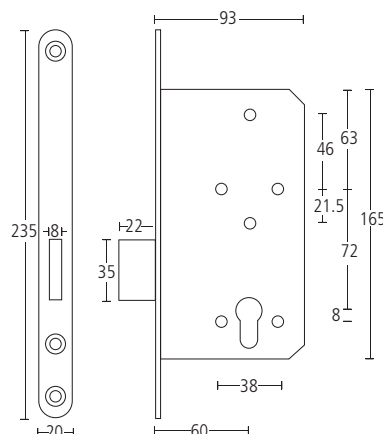

# @l!good hardware



## 7145N/13

Rebate component kit to suit 71 series locks.

Finishes: SS • PS

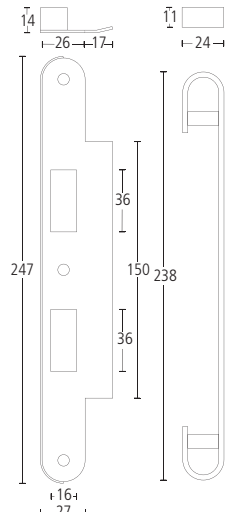

## 7179MG

Mortar guard to suit 71 series locks.

Finishes: SS • PS

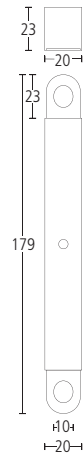



## 9960

Vertical mortice latch.

- 3 part low friction latchbolt
- Heavily sprung for lever handles
- Reversible latchbolt without opening lockcase
- UL listed and complies with ANSI 115.1. Suits standard ANSI preparation for metal doors
- Independently tested to BS EN 12209 3X|8|1|0|F|B|0|3|0
- CE Marked 1121-CPD-AG0055
- Certifire approved CF 623
- Incorporated in successful fire test and assessed to BS EN 1634-1 and BS 476 Pt 22 up to 90 minutes on timber doors and 120 minutes on metal doors
- 10 year guarantee

**Finishes:** SS • PS

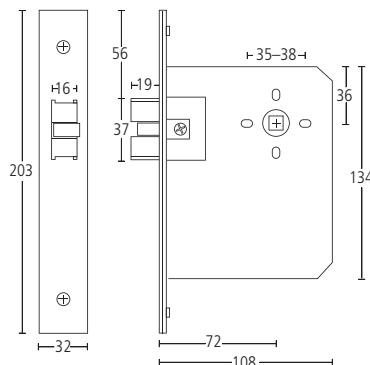

Suitable for severe usage doors and where a higher degree of security is required. Redlocks are available with a special bolt to allow use with approved 19mm electric release or monitor strikes and can be manufactured to incorporate microswitch monitors for alarm and access control.



## 9962HDP

Vertical euro profile cylinder mortice apartment entrance lock.

- 3 part low friction latchbolt
- Anti-thrust bolt
- Heavily sprung for lever handles
- Reversible latchbolt without opening lockcase
- Supplied with split spindle
- UL listed and complies with ANSI 115.1. Suits standard ANSI preparation for metal doors
- Independently tested to BS EN 12209 3X|8|1|0|F|3|B|A|3|0
- Independently tested to BS EN 179 3|7|6|B|1|3|4|2|A|B and 3|7|6|B|1|3|4|2|A|D
- CE Marked 1121-CPD-ABB035
- Certifire approved CF 623
- Incorporated in successful fire test and assessed to BS EN 1634-1 and BS 476 Pt 22 up to 90 minutes on timber doors and 120 minutes on metal doors
- 10 year guarantee

**Finishes:** SS • PS

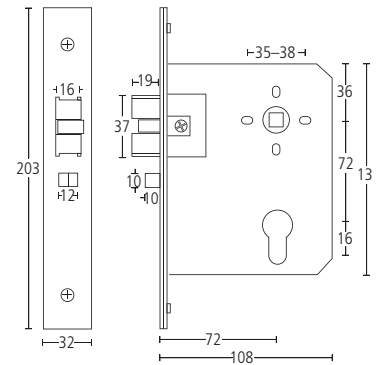



### 9964P

Vertical euro profile cylinder mortice deadlock.

- Deadbolt incorporating hardened steel pins
- UL listed and complies with ANSI 115.1. Suits standard ANSI preparation for metal doors
- Independently tested to BS EN 12209
- CE Marked 1121-CPD-AG0055
- Incorporated in successful fire test and assessed to BS EN 1634-1 and BS 476 Pt 22 up to 90 minutes on timber doors and 120 minutes on metal doors
- 10 year guarantee

Finishes: SS • PS

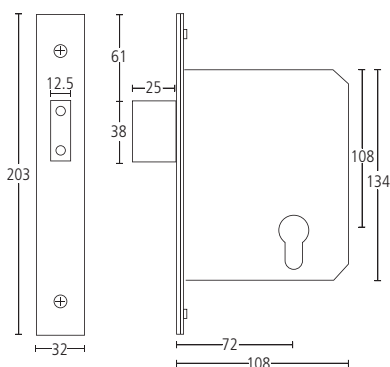

### 9968P

Vertical mortice bathroom lock.

- 3 part low friction latchbolt
- Anti-thrust bolt
- Heavily sprung for lever handles
- Reversible latchbolt without opening lockcase
- UL listed and complies with ANSI 115.1. Suits standard ANSI preparation for metal doors
- Incorporated in successful fire test and assessed to BS EN 1634-1 and BS 476 Pt 22 up to 90 minutes on timber doors
- 10 year guarantee

Finishes: SS • PS

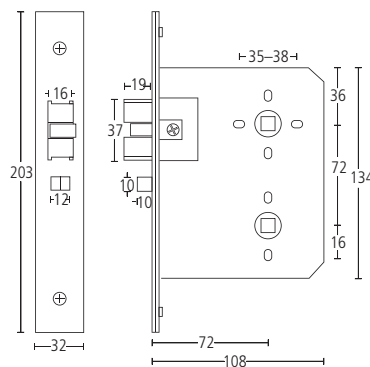

### 9980P

Vertical euro profile cylinder mortice deadlocking nightlatch.

- 3 part low friction latchbolt (For holdback facility please specify **9981HBP**)
- Anti-thrust bolt
- Heavily sprung for lever handles
- Reversible latchbolt without opening lockcase
- UL listed and complies with ANSI 115.1. Suits standard ANSI preparation for metal doors
- Independently tested to BS EN 12209 **3X8110F3KA30**
- CE Marked 1121-CPD-AG0058
- Certifire approved CF 623
- Incorporated in successful fire test and assessed to BS EN 1634-1 and BS 476 Pt 22 up to 90 minutes on timber doors and 120 minutes on metal doors
- 10 year guarantee

Finishes: SS • PS

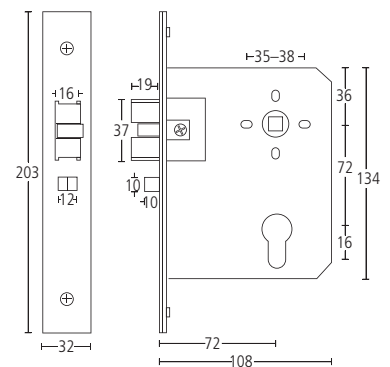



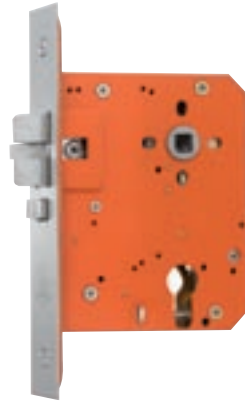

## 9990HDP

Vertical euro profile cylinder mortice escape nightlatch.

- Reversible latchbolt without opening lockcase
- 'Always free to escape' facility as per Secured by Design proposals
- Supplied with split spindle
- UL listed and complies with ANSI 115.1. Suits standard ANSI preparation for metal doors
- Independently tested to BS EN 179 

3	7	6	B	1	3	4	2	A	B
---	---	---	---	---	---	---	---	---	---

 and 

3	7	6	B	1	3	4	2	A	D
---	---	---	---	---	---	---	---	---	---
- CE Marked 1121-CPD-ABB035
- Certifire approved CF 623
- Incorporated in successful fire test and assessed to BS EN 1634-1 and BS 476 Pt 22 up to 90 minutes on timber doors and 120 minutes on metal doors
- 10 year guarantee

Finishes: SS • PS

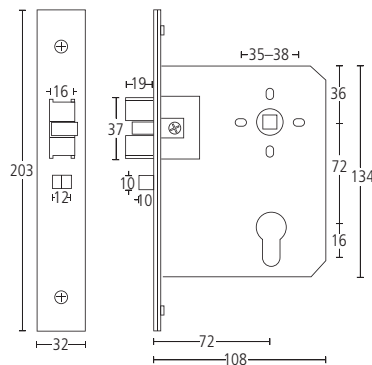

99' series redlocks are suitable for severe usage doors that require a higher degree of security. All mortice and solenoid bolts come complete with a 3 part low friction latchbolt, anti-thrust bolt and are heavily sprung for lever handles.

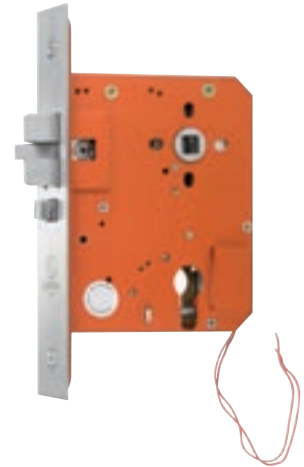

## 79941P1L/R

Vertical solenoid redlock with one lever solenoid controlled and the other lever free to escape.

- STATE HAND (EG. 79941P1L OR 79941P1R) - Left hand shown
- Supplied with split spindle
- **12 vDC fail secure**
- **Non-monitored**
- UL listed and complies with ANSI 115.1. Suits standard ANSI preparation for metal doors
- Independently tested to BS EN 179 

3	7	6	B	1	3	4	2	A	B
---	---	---	---	---	---	---	---	---	---

 and 

3	7	6	B	1	3	4	2	A	D
---	---	---	---	---	---	---	---	---	---
- CE Marked 1121-CPD-ABB035
- Certifire approved CF 623
- Incorporated in successful fire test and assessed to BS EN 1634-1 and BS 476 Pt 22 up to 90 minutes on timber doors
- 10 year mechanical guarantee, 1 year electrical guarantee

Finishes: SS • PS

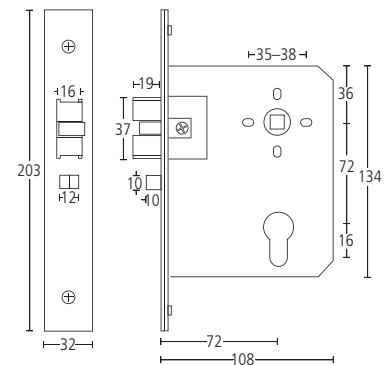

## 79941P2L/R

As above but 24 vDC fail secure.

Finishes: SS • PS

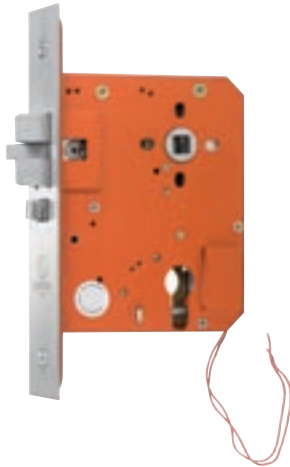

## 79942P1L/R

Vertical solenoid redlock with one lever solenoid controlled and the other lever free to escape.

- STATE HAND (EG. 79942P1L OR 79942P1R) - Left hand shown
- Supplied with split spindle
- **12 vDC fail safe**
- **Non-monitored**
- UL listed and complies with ANSI 115.1. Suits standard ANSI preparation for metal doors
- Independently tested to BS EN 179 376B1342AB and 376B1342AD
- CE Marked 1121-CPD-ABB035
- Certifire approved CF 623
- Incorporated in successful fire test and assessed to BS EN 1634-1 and BS 476 Pt 22 up to 90 minutes on timber doors
- 10 year mechanical guarantee, 1 year electrical guarantee

Finishes: SS • PS

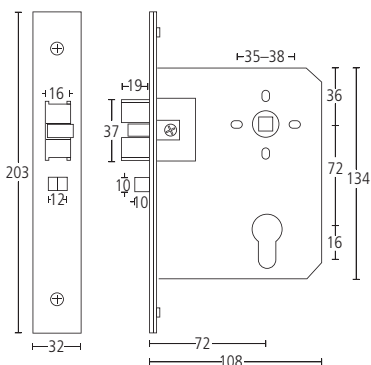

## 79942P2L/R

As above but 24 vDC fail safe.

Finishes: SS • PS



## 79945P5L/R

Vertical solenoid redlock with one lever solenoid controlled and the other lever free to escape.

- STATE HAND (EG. 79945P5L OR 79945P5R) - Left hand shown
- Includes request to exit function (RTE)
- Supplied with split spindle
- **12 vDC fail secure**
- **Twin-monitored**
- UL listed and complies with ANSI 115.1. Suits standard ANSI preparation for metal doors
- Independently tested to BS EN 179 376B1342AB and 376B1342AD
- CE Marked 1121-CPD-ABB035
- Certifire approved CF 623
- Incorporated in successful fire test and assessed to BS EN 1634-1 and BS 476 Pt 22 up to 90 minutes on timber doors
- 10 year mechanical guarantee, 1 year electrical guarantee

Finishes: SS • PS

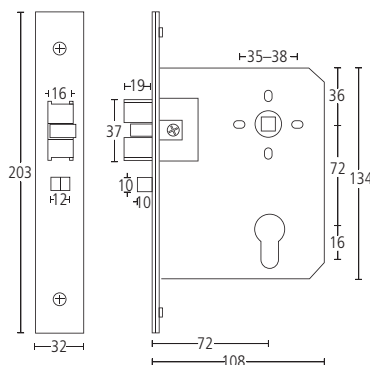

## 79945P6L/R

As above but 24 vDC fail secure.

Finishes: SS • PS

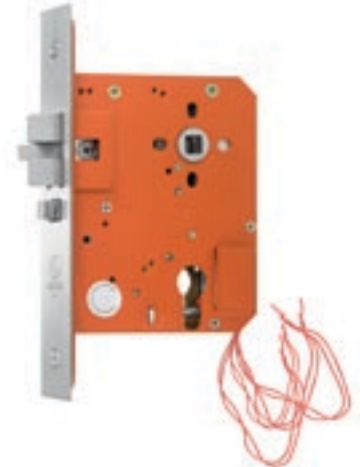

## 79946P5L/R

Vertical solenoid redlock with one lever solenoid controlled and the other lever free to escape.

- STATE HAND (EG. 79946P5L OR 79946P5R) - Left hand shown
- Includes request to exit function (RTE)
- Supplied with split spindle
- **12 vDC fail safe**
- **Twin-monitored**
- UL listed and complies with ANSI 115.1. Suits standard ANSI preparation for metal doors
- Independently tested to BS EN 179 376B1342AB and 376B1342AD
- CE Marked 1121-CPD-ABB035
- Certifire approved CF 623
- Incorporated in successful fire test and assessed to BS EN 1634-1 and BS 476 Pt 22 up to 90 minutes on timber doors
- 10 year mechanical guarantee, 1 year electrical guarantee

Finishes: SS • PS

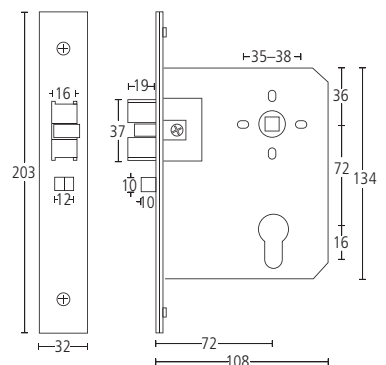

## 79946P6L/R

As above but 24 vDC fail safe.

Finishes: SS • PS



## 7604FS60

Vertical mortice latch.

- Radiused forend and strike plate
- Heavily sprung for lever handles
- Reversible latchbolt without opening lockcase
- Bolt through fixing holes for furniture
- Independently tested to BS EN 12209  
**[2H]8[1]0[F]-[B]0[2]0**
- CE marked 1121-CPD-AG0066
- Certifire approved CF537
- Incorporated in successful fire tests and assessed to BS EN 1634-1 and BS 476 Pt 22 up to 60 minutes on timber doors and 240 minutes on metal doors

**Finish: SS**

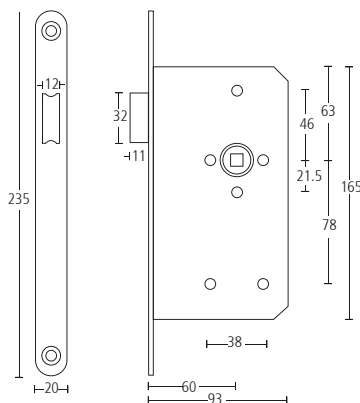

## 7608FS60

Vertical mortice bathroom lock.

- Radiused forend and strike plate
- Heavily sprung for lever handles
- Reversible latchbolt without opening lockcase
- Bolt through fixing holes for furniture
- Independently tested to BS EN 12209  
**[2H]8[1]0[F]-[B]0[2]0**
- CE marked 1121-CPD-AG0065
- Certifire approved CF537
- Incorporated in successful fire tests and assessed to BS EN 1634-1 and BS 476 Pt 22 up to 60 minutes on timber doors and 240 minutes on metal doors

**Finish: SS**

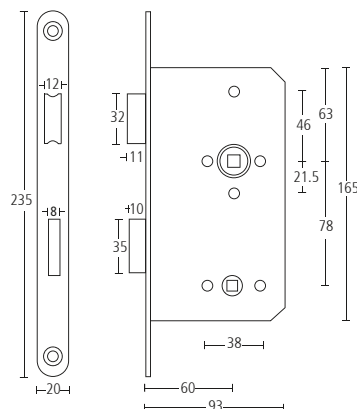

## 7679FS60

Vertical euro profile cylinder mortice lock.

- Radiused forend and strike plate
- Heavily sprung for lever handles
- Reversible latchbolt without opening lockcase
- Bolt through fixing holes for furniture
- Independently tested to BS EN 12209  
**[2H]8[1]0[F]3[B]C[2]0**
- CE marked 1121-CPD-AG0064
- Certifire approved CF537
- Incorporated in successful fire tests and assessed to BS EN 1634-1 and BS 476 Pt 22 up to 60 minutes on timber doors and 240 minutes on metal doors

**Finish: SS**

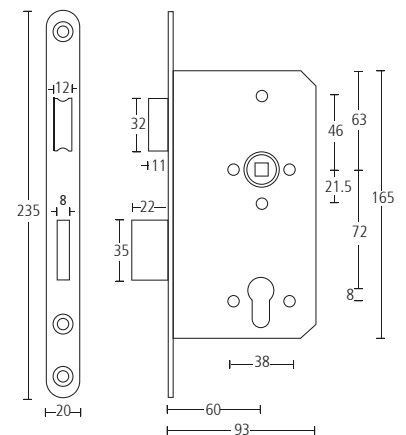



## 7681FS60

Vertical Euro profile cylinder mortice nightlatch.

- Radiused forend and strike plate
- Heavily sprung for lever handles
- Reversible latchbolt without opening lockcase
- Bolt through fixing holes for furniture
- Anti-thrust bolt inhibits the latch from being forced back when in the locked position

**Finish:** SS

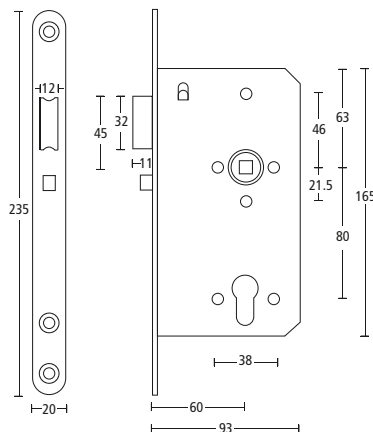

## 7682FS60

Vertical Euro profile cylinder mortice apartment lock.

- Radiused forend and strike plate
- Heavily sprung for lever handles
- Reversible latchbolt without opening lockcase
- Bolt through fixing holes for furniture
- Lever handles on both sides will withdraw latch bolt. If deadbolt is projected, the inside handle only will withdraw both bolts. Door then remains unlocked until manually re-locked from outside or turn from inside

**Finish:** SS

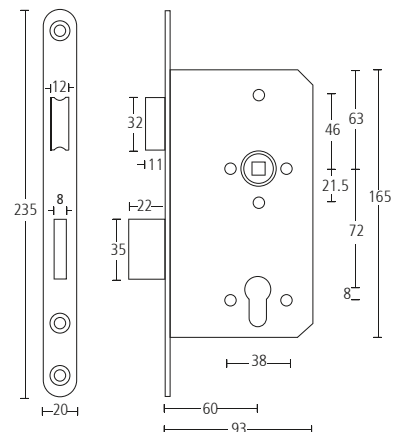



### 7686FS60

Vertical euro profile cylinder mortice deadlock.

- Radiused forend and strike plate
- Bolt through fixing holes for furniture
- Independently tested to BS EN 12209  
2H810F3BC00
- CE marked 1121-CPD-AG0063
- Certifire approved CF537
- Incorporated in successful fire tests and assessed to BS EN 1634-1 and BS 476 Pt 22 up to 60 minutes on timber doors and 240 minutes on metal doors

**Finish: SS**

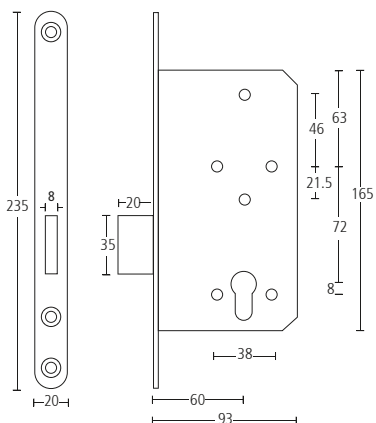



## overseas projects

### Allgood Worldwide

297 Euston Road  
London NW1 3AQ  
Telephone: +44 (0)20 7255 9330  
Facsimile: +44 (0)20 7383 7950  
E-mail: [info@allgoodww.com](mailto:info@allgoodww.com)  
Website: [www.allgoodww.com](http://www.allgoodww.com)

## uk projects

### Allgood plc

297 Euston Road  
London NW1 3AQ  
Telephone: 020 7387 9951  
Facsimile: 020 7380 1232  
E-mail: [info@allgood.co.uk](mailto:info@allgood.co.uk)  
Website: [www.allgood.co.uk](http://www.allgood.co.uk)

63-83 Brearley Street  
Birmingham B19 3NT  
Telephone: 0121 359 4415  
Facsimile: 0121 359 5832  
E-mail: [info@allgood.co.uk](mailto:info@allgood.co.uk)  
Website: [www.allgood.co.uk](http://www.allgood.co.uk)

28 Queen Street  
Manchester M2 5HX  
Telephone: 0161 834 6717  
Facsimile: 0161 834 6839  
E-mail: [info@allgood.co.uk](mailto:info@allgood.co.uk)  
Website: [www.allgood.co.uk](http://www.allgood.co.uk)

The Wright Business Centre  
1 Lonmay Road, Glasgow G33 4EL  
Telephone: 0141 773 6298  
Facsimile: 0141 771 9569  
E-mail: [info@allgood.co.uk](mailto:info@allgood.co.uk)  
Website: [www.allgood.co.uk](http://www.allgood.co.uk)